

Airwheel

MARS ROVER

www.airwheel.net

EN MARS ROVER User Manual

About User Manual

This manual includes safety usage instructions. Please make sure this manual is read through and fully understood before usage.

Inside the package you will find: the Airwheel , a battery charger, an extended air-pump connector, a user guide and manual.

Contents

About User Manual	I
Contents	01
1 Introduction	03
2 Safety	04
2.1 Safety Guidelines and Riding Etiquettes	05
2.2 Initiative Safety Measures	06
3 Airwheel Learning Tips	07
3.1 Before Getting Started	07
3.2 Learning Tips for First-Timers	08
3.3 Important Note	09
4 Usage	10
4.1 Component Drawing for Reference	10
4.2 Getting Started	10
4.3 Power Level	11
4.4 Speed Control	11
4.5 Tilting Protection	12
4.6 Charging the Battery	12
4.7 Water Resistance	13
5 Maintenance	13
5.1 Storage	13

Contents

	5.2 Inflation-----	13
	5.3 Changing the Tire-----	13
6	Specifications-----	15
7	Part VII Appendix I-----	18
	7.1 Check Tire Pressure of Mars Rover -----	18
	7.2 Models and Illustrations of Mars Rover -----	19
	7.3 Series Packing Content -----	26
	7.4 Charging Notes -----	27
	7.5 Relations Between Range and Load -----	28
	7.6 FAQ -----	29
	7.7 Road Test -----	31

1. Introduction

Airwheel is the state-of-the-art means of transportation adopting aerospace attitude control theory, fuzzy software algorithm, and gyroscope system to maintain balance by leaning forward and backward. Riders can control the vehicle to go forward, accelerate, decelerate, brake, etc. by leaning forward or backward. Similar to the techniques of riding a bicycle, the riders achieve balance on Airwheel by slightly tilting sideways.

Airwheel is the greenest and lightest smart scooter which can be easily carried into buses or subways, facilitating daily commuters.

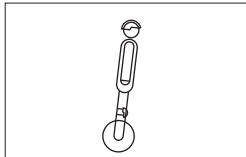

Forward

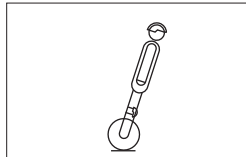

Accelerate

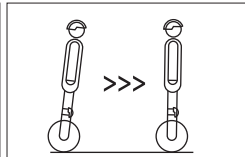

Decelerate

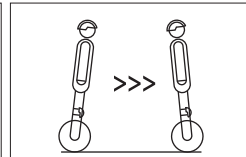

Stop/Brake

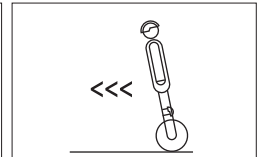

Backward

2. Safety

There are risks of riding or driving any vehicle. Airwheel is no exception. Please make sure this manual is read through and fully understood before getting started, and be alert when riding.

Important Note:

1. Sharp acceleration or deceleration or speeding via overly leaning forward or backward are strictly forbidden. When power level indicators show only one bar left, riding is not recommended. When it happens during the riding, please keep a low speed and recharge the Airwheel as soon as possible.
2. Do not ride Airwheel when risking any accidental falls. Safety goes first.

Attention:

1. Do wear helmet, gloves, elbow/knee pads or other necessary protection gears.
2. Do not ride Airwheel on rough or bumpy surfaces, such as muddy or gravel roads.
3. Do not ride Airwheel on wet, slippery surfaces, especially icy ones.
4. Do not ride Airwheel on slopes of over 15° gradient.
5. Do not allow children under 15 or the aged above 60 to ride Airwheel.
6. Drunk or drug riding Airwheel is prohibited.
7. Do not allow persons with high blood pressure, cardiac-cerebral vascular disease, or other high risk diseases to ride Airwheel.
8. Do not ride Airwheel in extremely cold winter.
9. Do not ride Airwheel in the rain.
10. Do keep slow speed when riding Airwheel on slopes.
11. Do not ride Airwheel in other unadvised situations caused by either personal or objective reasons.



You need lots of practice to grasp the skill before you ride the scooter safely. If you are not skilled, or fail to follow the user guide of this product, it may cause rider or others injury or property loss. Our company only takes the responsibility for product defects or damage, and we are NOT responsible for physical injury or property loss related with using products.

2.1 Safety Guidelines and Riding Etiquettes

Please learn and abide by local laws and regulations when riding Airwheel. Be careful and considerate of others, and take precaution of accidents and collisions.

Please ride at safe and proper speed and make sure your Airwheel is under control. Keep yourself a safe distance from pedestrians and vehicles and always be prepared to stop.

Respect pedestrians and avoid startling pedestrians, especially children. When approaching from behind, announce yourself and slow down to walking speed when passing. Pass on the left whenever possible. When approaching a pedestrian from the front, stay to the right and slow down.

Keep a safe distance from other Airwheel riders and always avert from obstacles. Unless there's ample space for other pedestrians, please do not ride side by side with fellow Airwheel players.

Please avoid riding in poor light unless necessary, and make sure in this scenario you ride at slow, safe speed with care and geared with mounted driving lights if possible.

Please relax your body when riding, bend your knees and elbows slightly and look straight forward.

Riding backward can be dangerous. For emergency, ride slowly backward in necessary avoidance of obstacles.



Please lean forward slightly to accelerate instead of lunging forward suddenly. You may lose balance and get yourself hurt in aggressive acceleration. It is the main cause of accidental falling overs.

2.2 Initiative Safety Measures

Please read through this manual and make sure it is fully understood.

Do not allow others try to your Airwheel, unless he/she has read through this manual.

Please do wear safety gears while riding Airwheel. Make sure your helmet is comfortably fit and qualified for safety protection. Riders may wear glasses, elbow/knee pads according to their own experiences.

Please do not ride Airwheel when you are under the weather or affected by alcoholic/drugs and not able to follow the instructions on the manual.

Please stop riding immediately when Airwheel starts alerting for low battery or over speed. Charge your Airwheel in time to ensure safe and smooth usage.

Make sure to power off Airwheel before moving it. Do not lift Airwheel on the wheel in case your fingers get caught between the tire and case.

Check your Airwheel carefully for any loosened or damaged parts everytime prior to usage and do not ride before proper troubleshooting.

3. Airwheel Learning Tips

3. 1 Before Getting Started

For first-timers, be sure to equip yourself with comfortable sportswear and sneakers. Warm up your body and keep your body agile. Considering the average human athletic skills, the height of pedal is set 10cm from ground only, which guarantees your safety in case of falling over. A Helmet, gloves, knee and ankle pads are also essential for first-timers.

To start, please bring Airwheel to open space and watch out for obstructions and bumpy terrains.

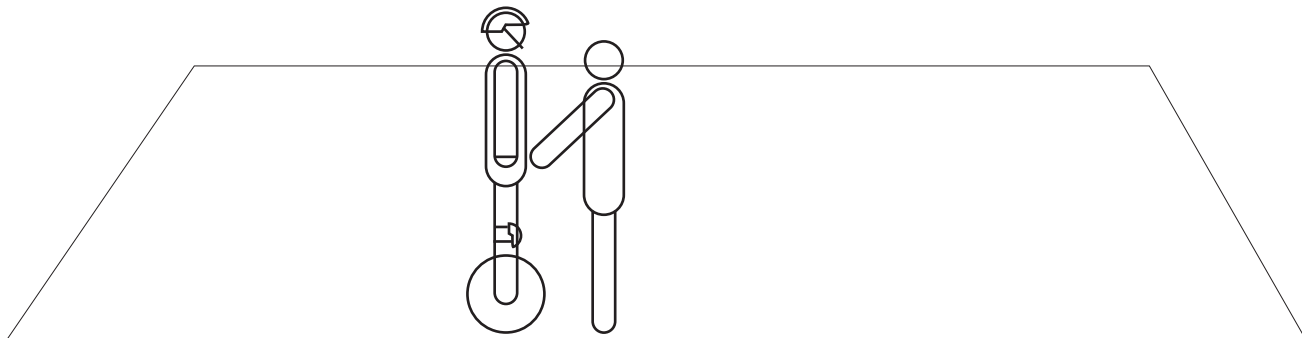

3.2 Learning Tips for First-Timers

1. Place Airwheel vertically on the ground by one hand and power it on.
2. Unfold the pedals and straddle Airwheel.
3. Place one foot on the center of a pedal and bend the leg slightly to press on the cushion rubber tightly.
4. Lift your hand that holds Airwheel, stand upright naturally and look straight forward. Shift your body weight to the leg standing on the ground and try to achieve lateral balance.
5. Maintain this position and shift your body weight gradually to the other leg and lift your supporting leg from the ground and try to maintain momentary balance.
6. Please follow and practise the above steps before starting gliding with one foot on a pedal .
7. After being able to glide with one foot smoothly, place another foot on a pedal and relax your legs for better balance.
8. Ride along and try to change directions by shifting body weight or twisting your waist slightly.

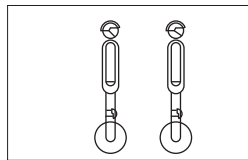
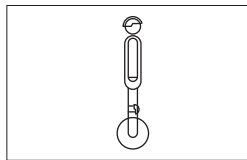
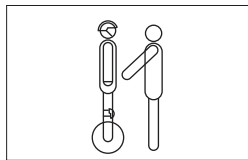
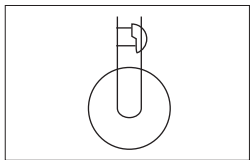

3.3 Important Note



Training belt is highly recommended for beginners , which reduces risk of falling over.

Warnings

1. Players under 18 or over 45 are supposed to find themselves learning partners.
2. Make sure to check the power level and tire before riding.
3. Please control speed before riding smoothly.

4. Usage

4.1 Component Drawing

(See Page20~25)

- ① Power Button
- ② Power Level Indicators
- ③ Charger
- ④ Pedal (Foldable)

4.2 Getting Started

Place Airwheel vertically on the ground and turn it on. The Power Level LED Indicators will be on and the buzzer will beep, and the unit is ready to be used.

If Airwheel tilts either forward or backward after powered on, please wait until it adjusts to upright position before riding.

4.3 Power Level

A four-bar LED indicator is applied to indicate the power level. All fours will be lit when power level is over 85% and will go off one by one as the level drops. Please check power level every time before usage to ensure there is enough power for a return trip. You may recharge it every time after usage.

When power level falls lower than 15%, all four lights will blink and the buzzer will beep. The front end of the pedal will sink to force you to decelerate and eventually stop. Please do not attempt to ride again, otherwise you may suffer a sudden loss of power and fall over.

Duration range will be limited during winter, since the battery performance drops sharply in cold weather. For instance, at -15°C , the discharge capacity is only about half compared to that at room temperature.

4.4 Speed Control

To prevent injuries caused by overspeed, Airwheel sets a maximum speed. When speed exceeds 12km/h, the front end of the pedal will rise gradually and when the speed exceeds 16km/h, the pedal will pose a 10° angle to the leveling surface, which stop you from inclining further to accelerate. The pedal will flatten itself gradually as the speed decreases.

NOTE: Please do not incline further to accelerate when approaching the maximum speed.

4.5 Tilting Protection

When Airwheel tilts to over 45° sideways, e.g. when Airwheel turns over, the control system will activate tilting protection. The motor will stall immediately to prevent injuries.

The buzzer will start a long buzz and the LED indicators will flash at the same time.

To deactivate this, power off the unit to reboot.

4.6 Charging the Battery

Power on the A/C source after plugging in the charger, otherwise the charger will stop working to ensure charging safety. Airwheel is equipped with a high-power charger. Normally it takes about 90-250 min to full charge and 60-160 min to 80% full (check the specification table for detailed info). The indicator lights will turn red when charging and green when charging completes.

If not for emergencies, please wait until charging completes before unplugging, for battery protection board will conduct SOC equalization as charging completes.

4.7 Water Resistance

Airwheel is IP56 water-proof rated, which sails safely in 10mm (or below) of water. You may ride it in drizzles shortly, yet avoid sinking it in deep water or riding it on rainy days for a long time.

5. Maintenance

5.1 Storage

Please store Airwheel in a dry location. For non-regular users, recharge the battery every 90 days to maintain the battery life and store Airwheel only after it's fully charged.

5.2 Inflation

Use the extended connector to inflate the tire. Without the connector, you may fail to pump air into the wheel.

5.3 Changing the Tire

To repair or change the inner or outer tire, open one side cover (the one without indicator lights). First, unscrew the 14 bolts on the sides, then the 6 bolts on the center, and then open the casing. Take special care with the connecting wires set alongside the inner rim, no dragging or cracking open.

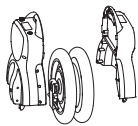

Q1

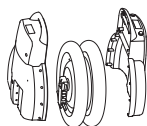

Q3

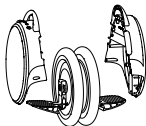

Q5

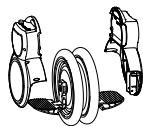

Q6

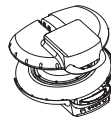

X3

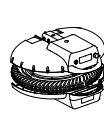

X8



Note:

- A. Electric Sparks may flash momentarily at the end of the power cord after maintenance. That is normal and no need to panic.**
- B. Do not open the cap on the side cover with indicator lights.**

6. Specifications

Item	Specification	Parameters	Details
Performance	Maximum Speed	About 18 km/h	Alert activated at 12km/h
	Safe Climbing Angle	About 15°	Riders weighing 60kg get up to 18°
	Battery	88.8Wh/130Wh/170Wh/260Wh/340Wh	Protection board with SOC equalization
	Temperature	-10°C~40°C	Best at 20°~30°C
	Weight Limit	120Kg	
	Charger Voltage	AC 220V 50-60Hz	Optional:110V or 110V-240V
	Charge Time	130Wh: 90min	
170Wh: 120min			80% charged in 80min
260Wh: 180min			80% charged in 90min
340Wh: 250min			80% charged in 160min
Safety Measures	Tilting Protection	45° side-to-side on average	Motor stalls when tilting over 45°
	Speed Limit Protection	Activated at 12Km/h	Front part of pedal will rise to prevent further acceleration

Item	Specification	Parameters	Details
	Low Battery Protection	Activated on 15% power battery	Front part of pedal will rise to decelerate till fully stop
Exterior Parameters	Size	X3:Height: 450mm, Length: 395mm, Thickness: 160mm	
		X8:Height: 497mm, Length: 450mm, Thickness: 168mm	
		Q1:Height: 466mm, Length: 348mm, Thickness: 189mm	
		Q3:Height: 518mm, Length: 408mm, Thickness: 200mm	
		Q5:Height: 530mm, Length: 373mm, Thickness: 185mm	
		Q6:Height: 531mm, Length: 352mm, Thickness: 190mm	
	Pedal Height	Q1:100mm X3/X8/Q3:115mm Q5/Q6 :110mm	When dismounted
	The Size	X3/Q3/Q5/Q6 : 14in	
X8: 16in Q1: 12.5in			
Main Body Weight	X3:9.8kg/ X8:11.1kg		
	Q1:10.6kg/Q3:13.7kg/Q5:11.5 kg/Q6:11.1kg		
Alert	Power and Error Indication	LED Power Indicators	Red when turned on, Blinks when protection activated

Item	Specification	Parameters	Details
Alert	Alert Sound	Beep when powered on ; Continual Beep when low power protection activated	
	Alert Sound	Long buzz when tilting sideways.	
Accessories	Standard	Charger, Extended Pump Nozzle	
	Optional	LED Flash Light , Training Band	

* Specification table is for reference only, please visit our website for latest update.

7. Part VII Appendix

7.1 Check Tire Pressure of Mars Rover

Generally Airwheel's tire pressure is supposed to range between 1.5-2.0kg/cm². High tire pressure contributes to smaller friction force and longer battery range, yet delivers less damping effect.

7.2 Models and Illustrations of Mars Rover

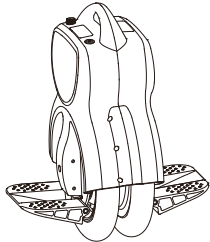

Q1

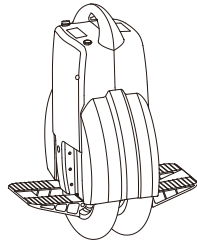

Q3

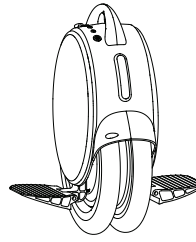

Q5

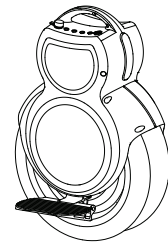

Q6

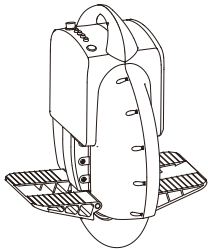

X3

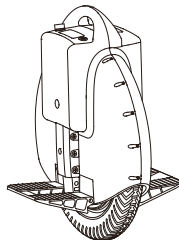

X8

Q1

Charge Port and Cover Cap

Handle

LED Indication Board

LOGO

Power Button

Pedal

Pedal

Wheel Hub

Tyre

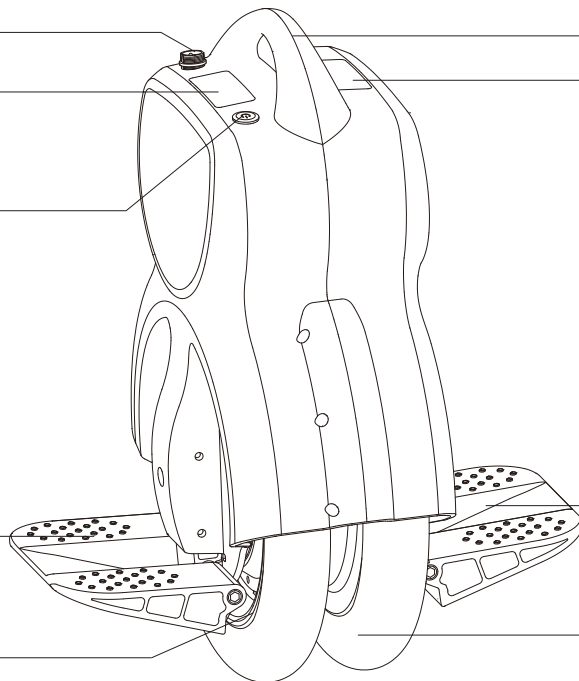

Q3

Charge Port and Cover Cap

LED Indication Board

Power Button

Pedal

Wheel Hub

Handle

LOGO

Pedal

Tyre

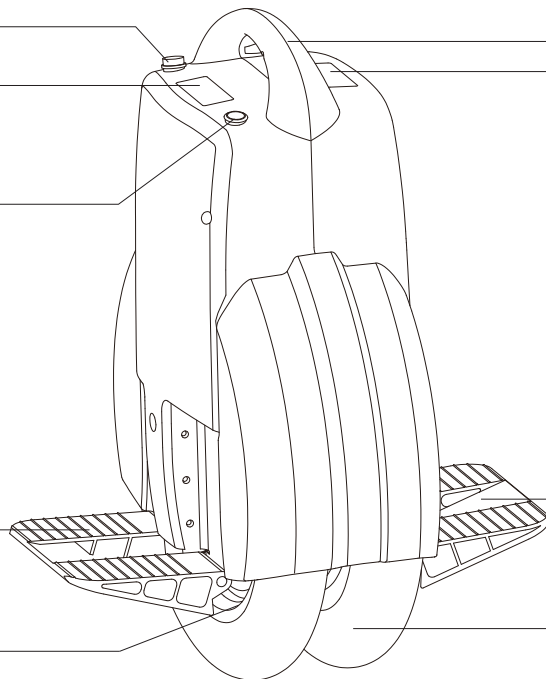

Q5

Handle

Charge Port and Cover Cap

LED Indication Board

Power Button

Pedal

Wheel Hub

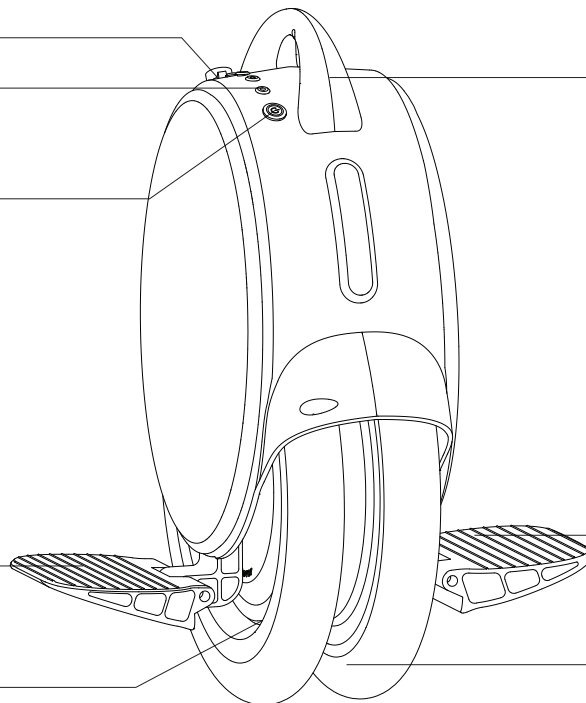

Pedal

Tyre

Q6

Charge Port and Cover Cap

LED Indication Board

Power Button

Handle

LED Atmosphere Light

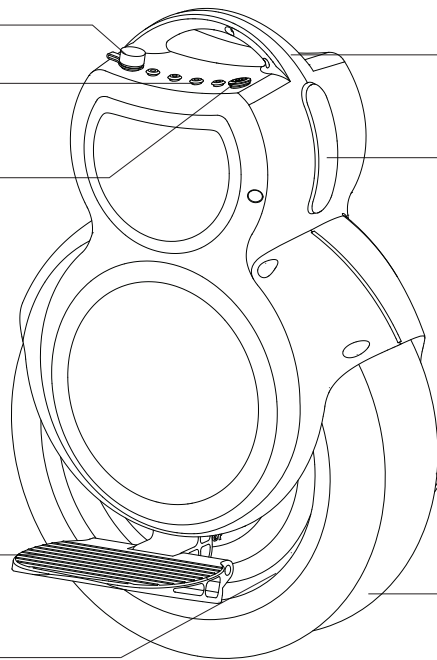

Pedal

Pedal

Wheel Hub

Tyre

X3

Charge Port and Cover Cap

LED Indication Board

Power Button

Handle

Pedal

Pedal

Wheel Hub

Tyre

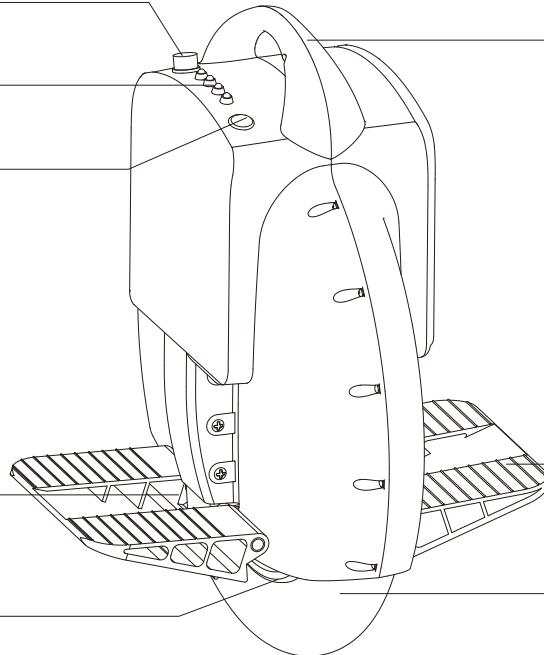

X8

Charge Port and Cover Cap

LED Indication Board

Power Button

Pedal

Wheel Hub

Handle

Pedal

Tyre

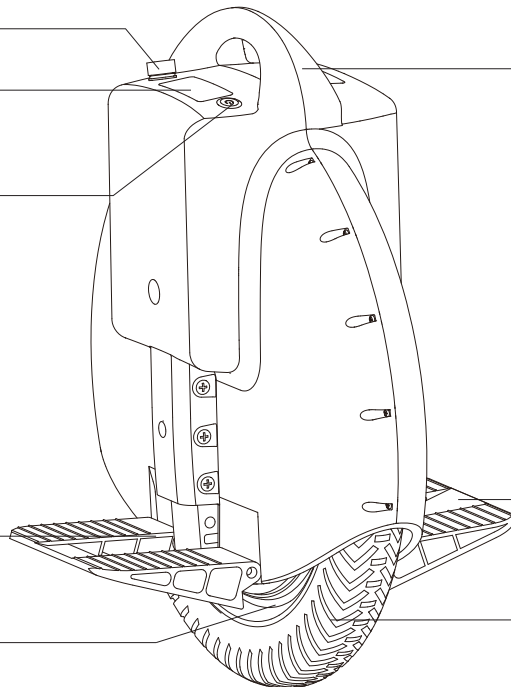

7.3 Packing Contents

Check the Items Contained in the Packing Box

Open the packing box and take out Airwheel with care. Airwheel is labelled with a “Road Test Approved” sticker, which means it’s been tested before leaving factory.

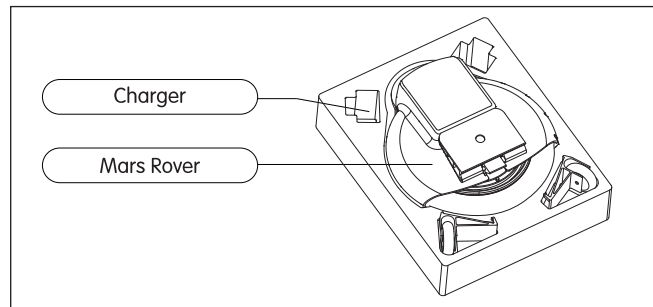
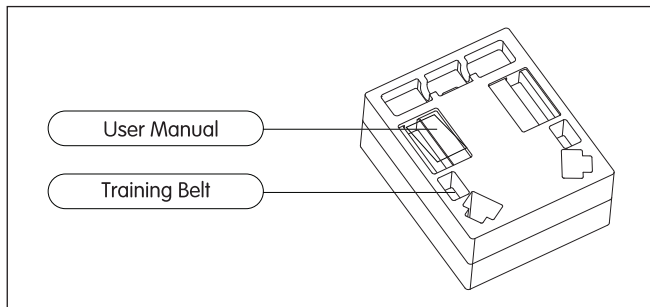

Please lift Airwheel upward carefully when taking it out from the packing box. Use one hand to grip the handle and the other to seize the pedal pillar instead of hauling the tire straightly, by this way your fingers might be caught in the hub.

7.4 Charging Notes

Charge Note : Plug Airwheel to the charger before connecting the charger to power supply.

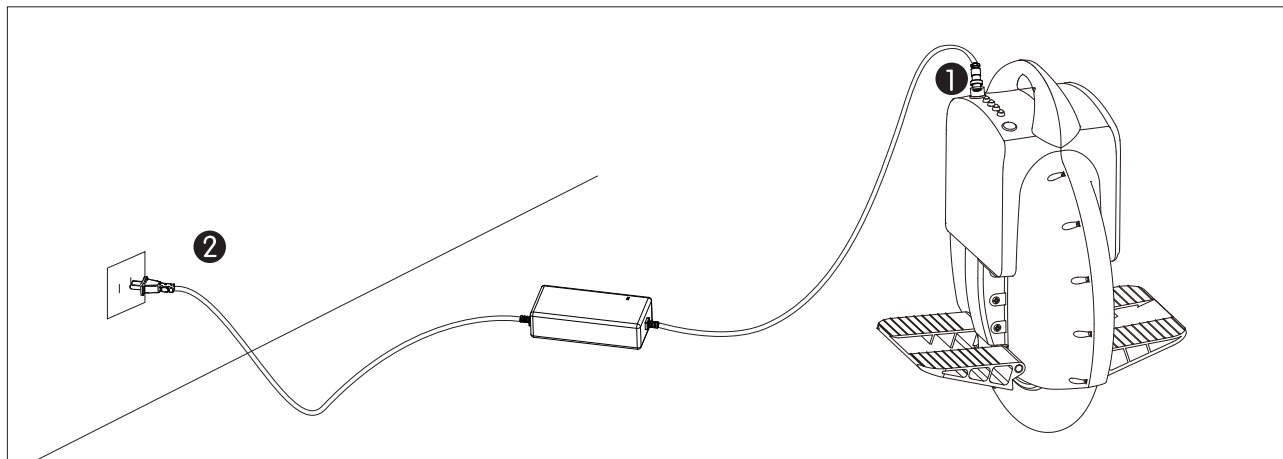

7.5 Relation between Range and Load

Similar to the relations between fuel consumption and cargo load, range per charge is related to rider's body weight. In light of the conclusion we draw from practical tests (rider's weight: 60kg; riding speed: 7km/h and constant; road condition: smooth and flat), range per charge falls by 1.5~2.0km for each additional gain of 10kg.

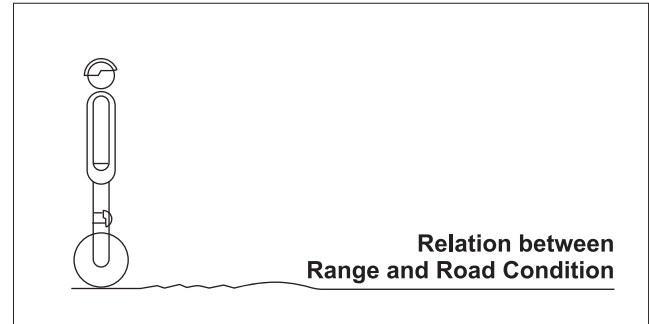
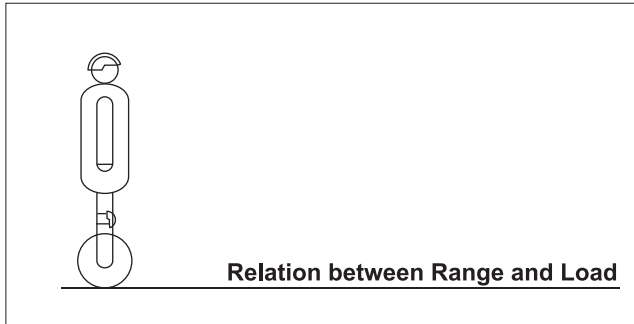

7.6 FAQ

Q: How can I tell the front and rear end of Airwheel?

A: Front and rear end are not strictly defined on Airwheel Mars Rover, it's depended on personal riding preference. Typically the side with power button on the right is prioritized as the front end to facilitate turning it on and off.

Q: When I turn on my Airwheel, all 4 LED indicators are on before blacking out a second later, and then after 3 seconds they are lit again, is it normal?

A: Airwheel initiates with testing its power level indicator and beeper before launching a self-inspection of the other major parts when the indicators are lit 3 seconds later. That's perfectly normal.

Q: Front end of my pedal will rise without launching an over speed alert, is it normal?

A: The front end of pedal will rise when the speed exceeds pre-set value (10km/h) and when the speed picks up to 12km/h, the front end of pedal will pose a 10° angle and alert will be activated to prevent further acceleration.

Q: Can I customize Airwheel to lift the speed limit?

A: Sorry can't. Over speed protection is designed to ensure player's own safety during usage.

Q: How can I tell whether my Airwheel is fully charged or not?

A: There's a charging indicator light on the charger. A red indicator light indicates that Airwheel is under charging and a green one indicates that Airwheel is fully charged or not charged.

Q: How long does it take to be fully charged?

A: Airwheel's exclusive charger is featured with compensating function. When charging for roughly 1 hour, the charger will be on green, which indicates power level reaches 80% full. Then the battery will perform SOC equalization before getting charged again and this process will be conducted 3 times till the battery is fully charged.

Q: Can I ride Airwheel in the rain?

A: It's forbidden, and please ride slowly when puddles are not drained after rain to avoid bringing water to the internal through the tire.

Q: Am I supposed to reboot Airwheel after it falls over every time?

A: Yes, when Airwheel falls over, it's internal electronic system will launch tilting protection immediately to protect the player, surrounding passengers and itself. You have to lift it upright and reboot to ride again.

Q: I can't get my Airwheel charged, why?

A: Please follow the steps to charge your Airwheel: First, plug the charger with Airwheel, then connect the charger to power supply, otherwise the charge process won't start.

Q: My Airwheel quivers when travelling at high speed and I can barely stand on it, how to fix this problem?

A: When you are riding at high speed, the front part of pedal will rise, which shifts the center of gravity backward and makes it tricky to maintain balance on Airwheel, especially on bumpy terrains. Slow down a bit and this problem will be fixed. In addition, uneven tire patterns may also lead to this problem. In this scenario, lay Airwheel flat on ground and roll the wheel to check whether the tire covers the wheel rim closely, if not, you need to deflate and adjust the tire before inflating it again.

Q: Should I power off Airwheel to charge or not?

A: Please power off Airwheel for charging.

7.7 Road Test

Airwheel's battery range is closely related to ambient temperature, weight, riding manner and battery discharge capacity. Test condition: environment temperature:30°C ; tester's weight: 60kg; test venue: indoor stadium. The tester rides Airwheel at a constant speed of 8km/h using standard riding manner without any tricks.

Test result: 10% battery capacity remained when test finished. However in practice, lithium battery will conduct a discharge restriction for user's safety and battery life expectancy, which will reserve 30% battery capacity.

